

VSF 11011

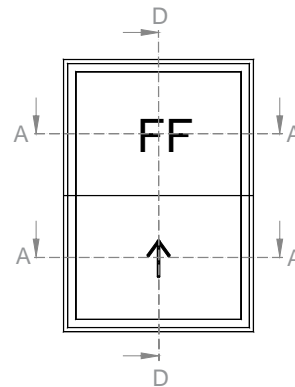

VSF 21021
*als Kämpfer
waagrecht*

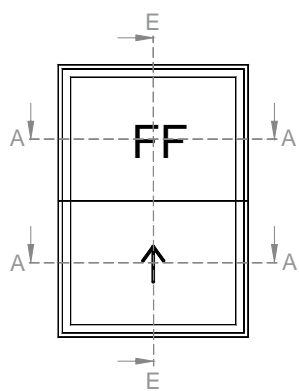

VSF 21031
*als Stulp
waagrecht*

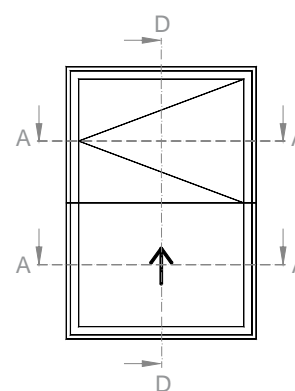

VSF 21041
in 3 Varianten:
1. als Dreh
2. als Kipp
3. als Kipp-Putzschere

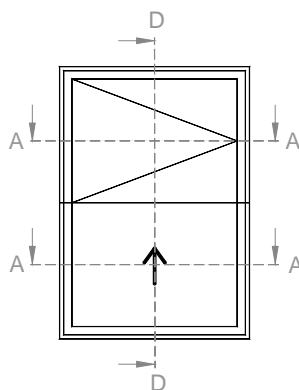

VSF 21051

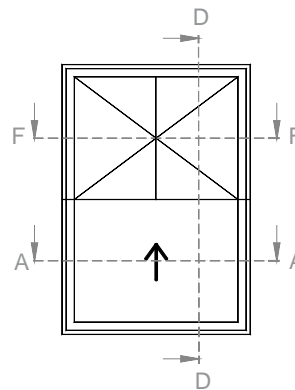

VSF 31061
als Stulp

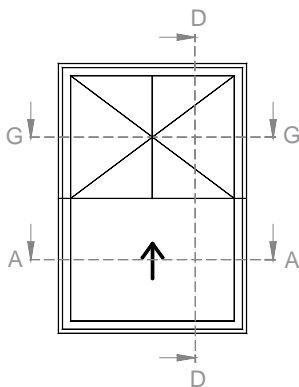

VSF 31071
mit Pfosten

WIN - Hochschieb Fenster Ausführung VSF 11011

Schnitt A - A

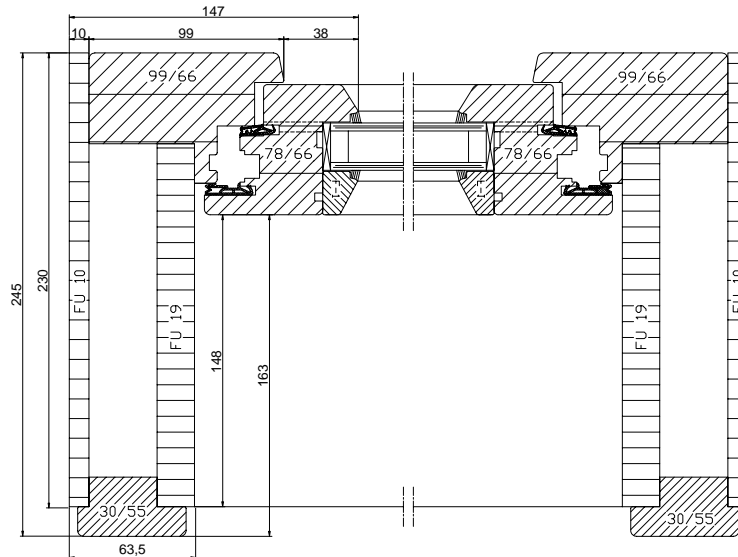

Schnitt B - B

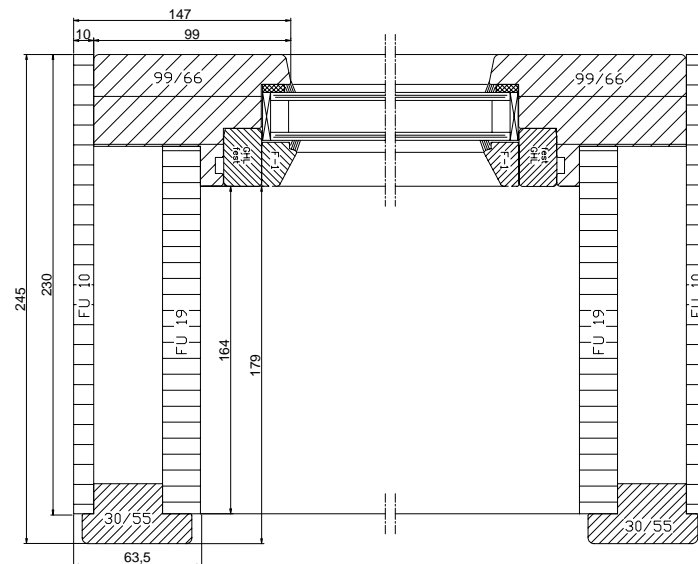

Systeminformation

VSF 11011

Schnitt C - C

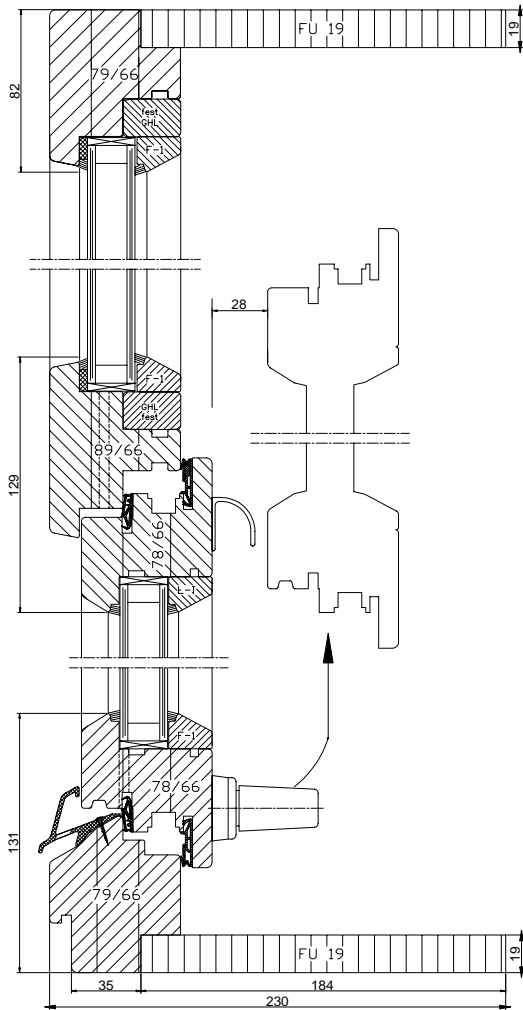

VSF 21021 /
21041 / 21051 / 31061 / 31071
Schnitt D - D

mit Regenschiene

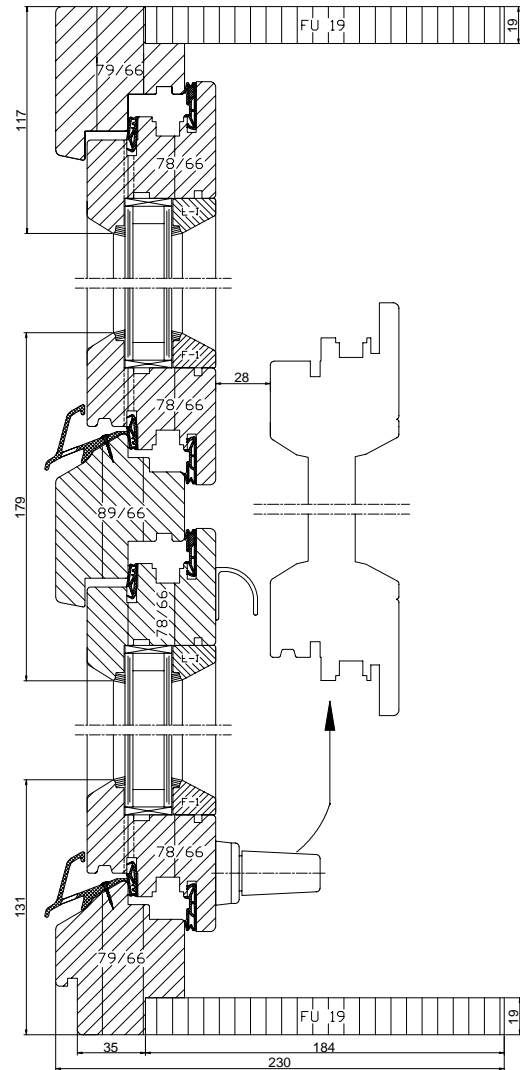

VSF 31061

Schnitt F - F

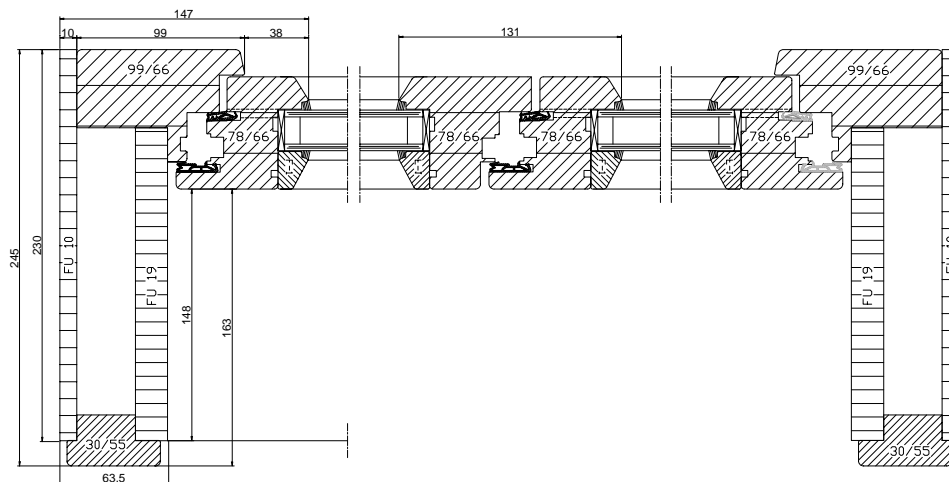

-
Schnitt E - E

VSF 21031

mit Regenschiene

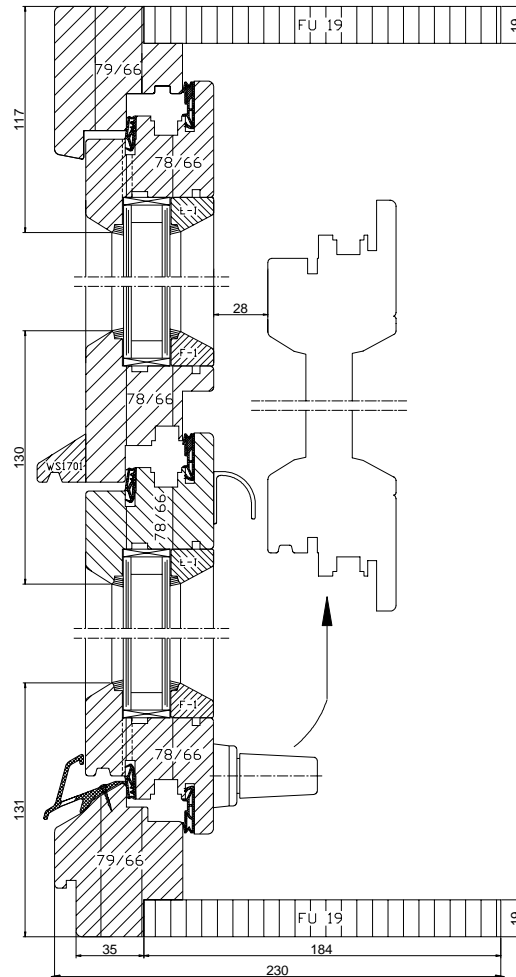

-
Schnitt G - G

VSF 31071

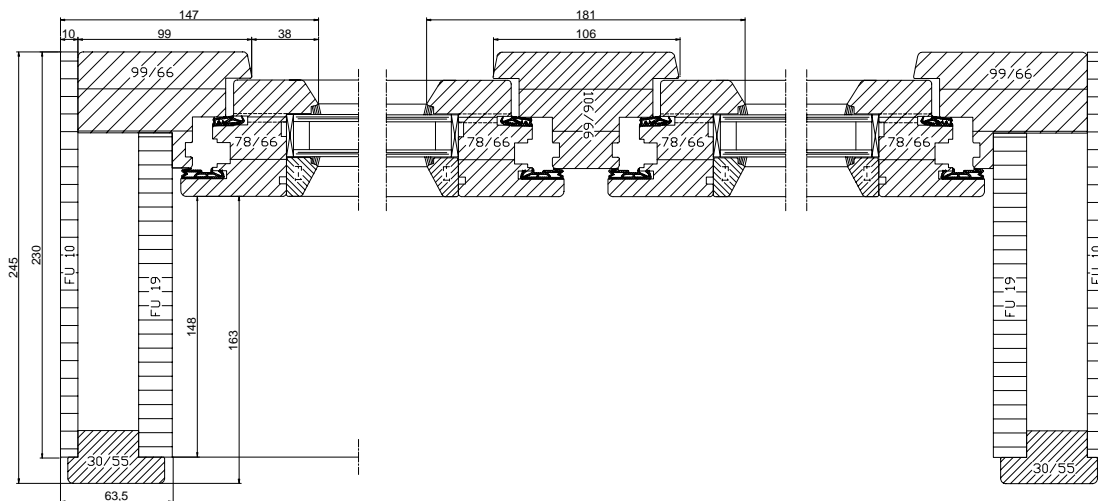

Hochschiebefenster Holz Typ "S" ohne unteres Rahmenquerstück (Verkaufsfenster)

www.adrik.de

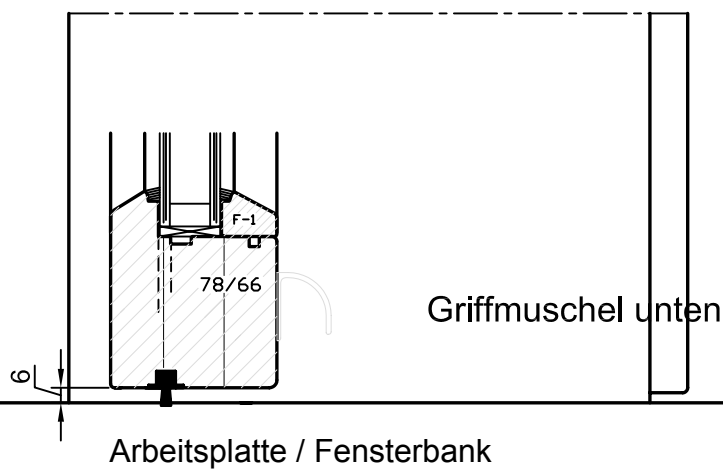
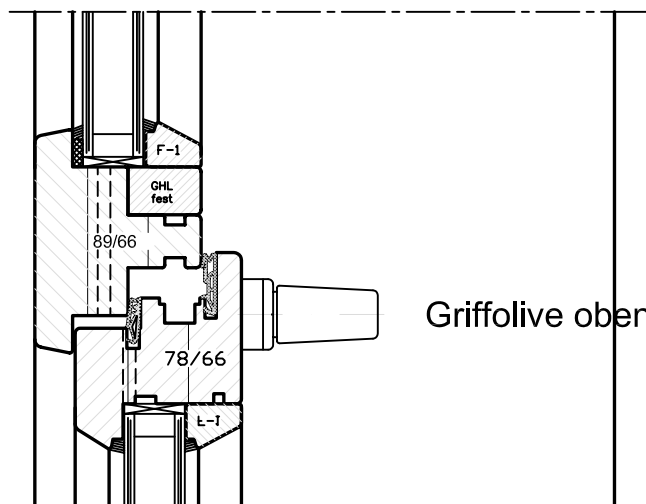
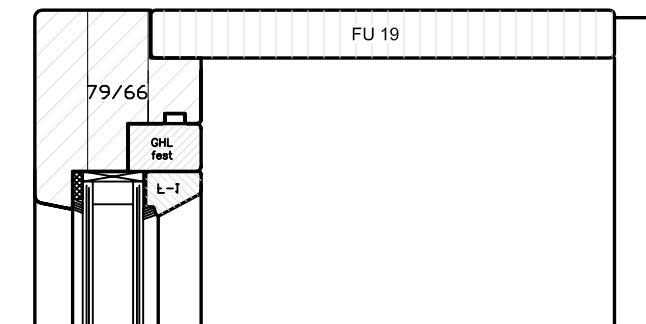

Bemerkung:
Die Dichtigkeit in Bezug auf Regen o.ä. und Wind ist im unteren Bereich stark eingeschränkt !

Detail Kopplung von 2 Hochschiebefenster Typ "S"

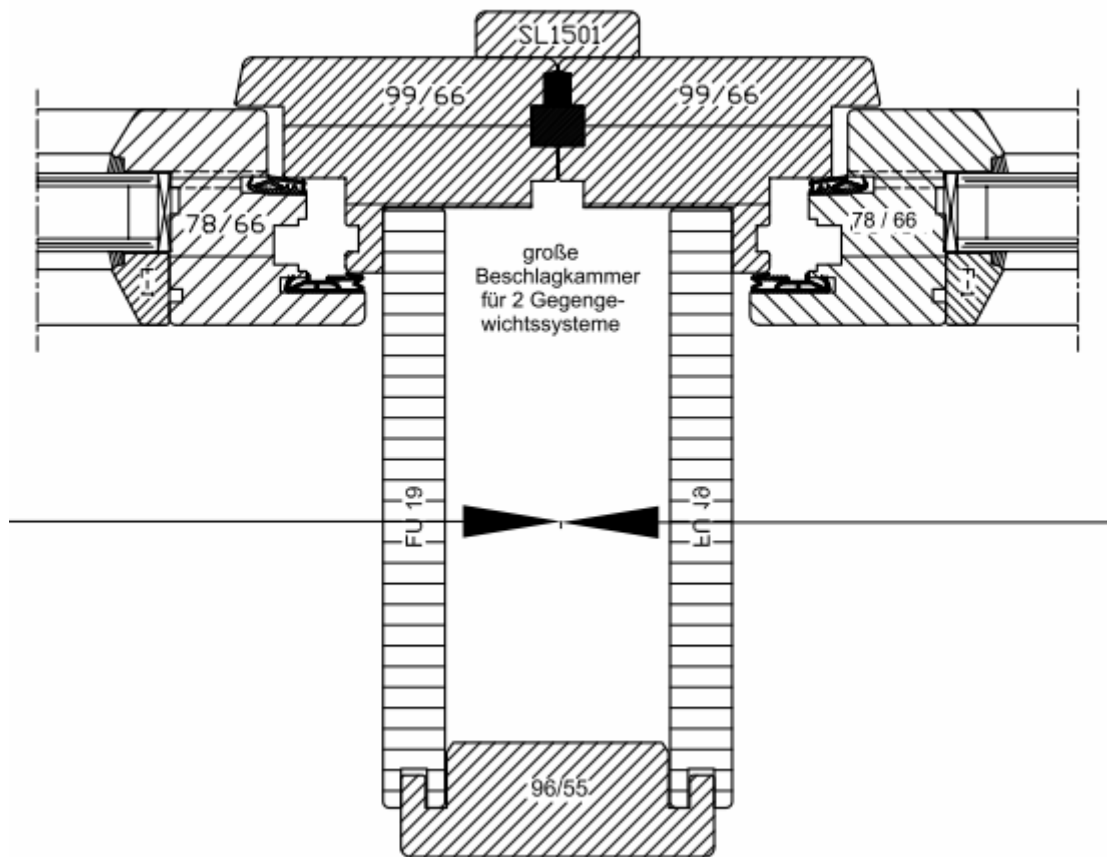

Kopplung von 3 Hochschiebefenster Typ "S"

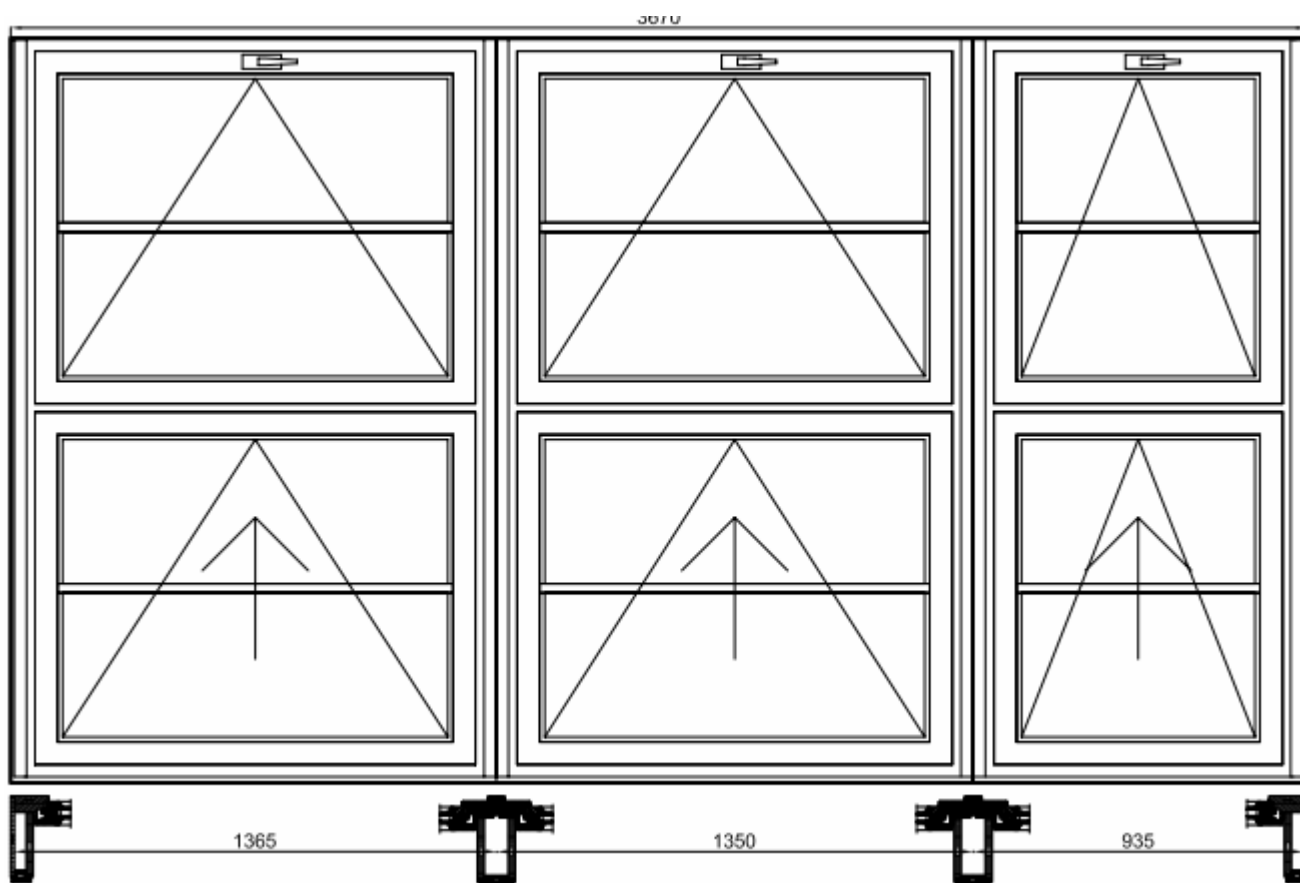

Systeminformation Holz-Alu Hochschiebefenster

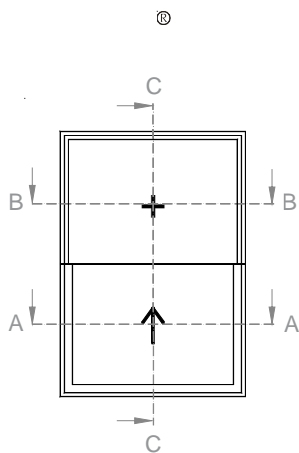

VSF-HoMe 11011

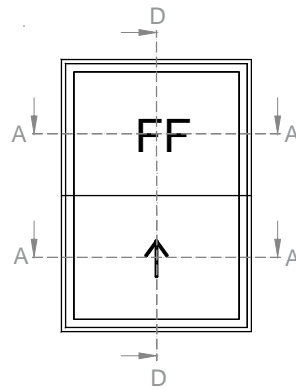

VSF-HoMe 21021
*als Kämpfer
waagrecht*

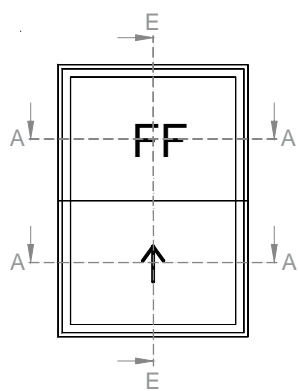

VSF-HoMe 21031
*als Stulp
waagrecht*

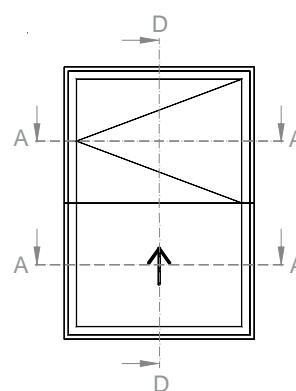

VSF-HoMe 21041

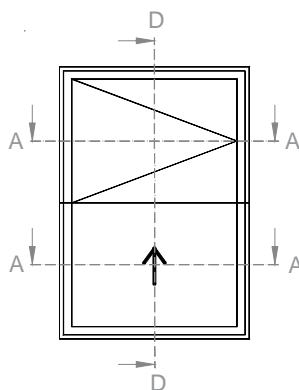

VSF-HoMe 21051

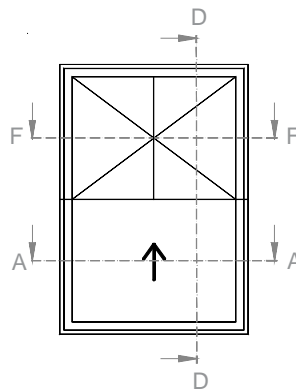

VSF-HoMe 31061
als Stulp

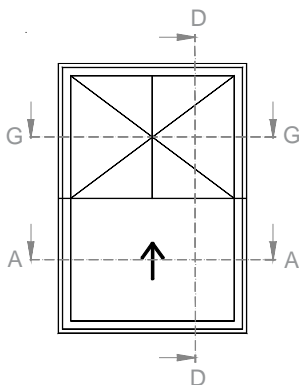

VSF-HoMe 31071
mit Pfosten

- A ®
 21051 / 31061 / 31071
 Schnitt A - A

VSF-HoMe 11011 / 21021 / 21031 / 21041 /

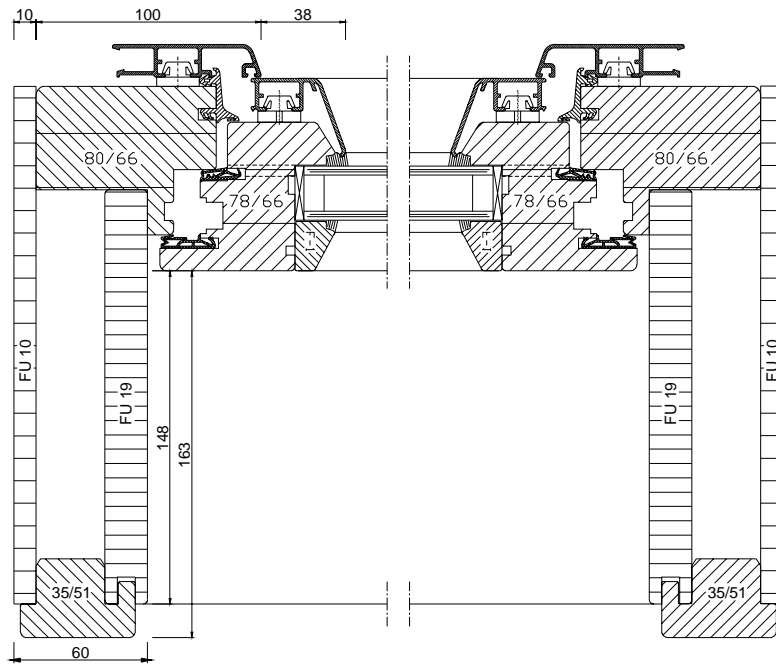

®
 Schnitt B - B

VSF-HoMe 11011

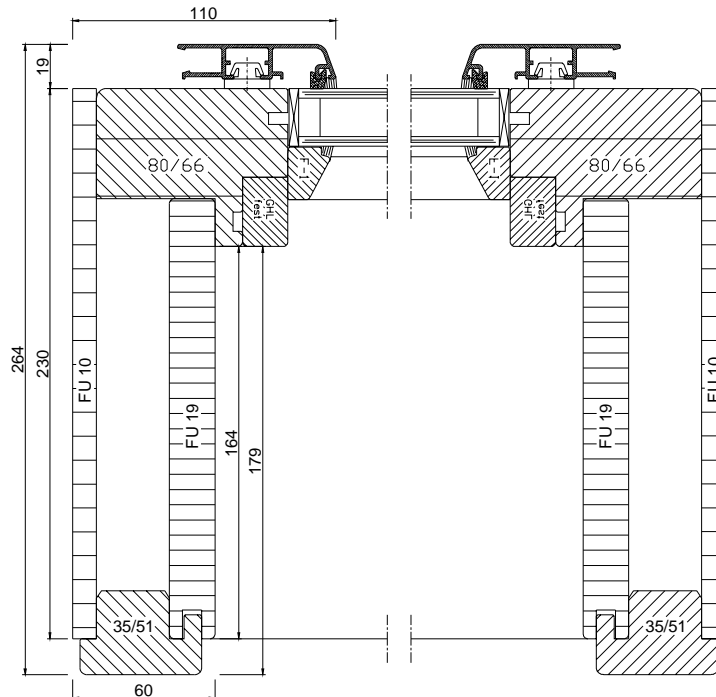

Systeminformation

® (Holz-Metall) -
Ausführung VSF-HoMe 11011
Schnitt C - C

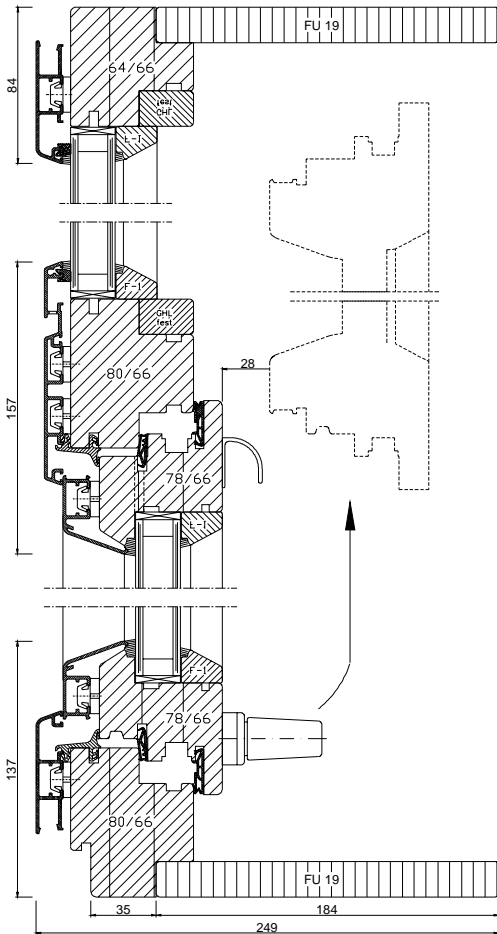

® (Holz-Metall) -
Ausführung VSF-HoMe 21021 /
21041 / 21051 / 31061 / 31071
Schnitt D - D

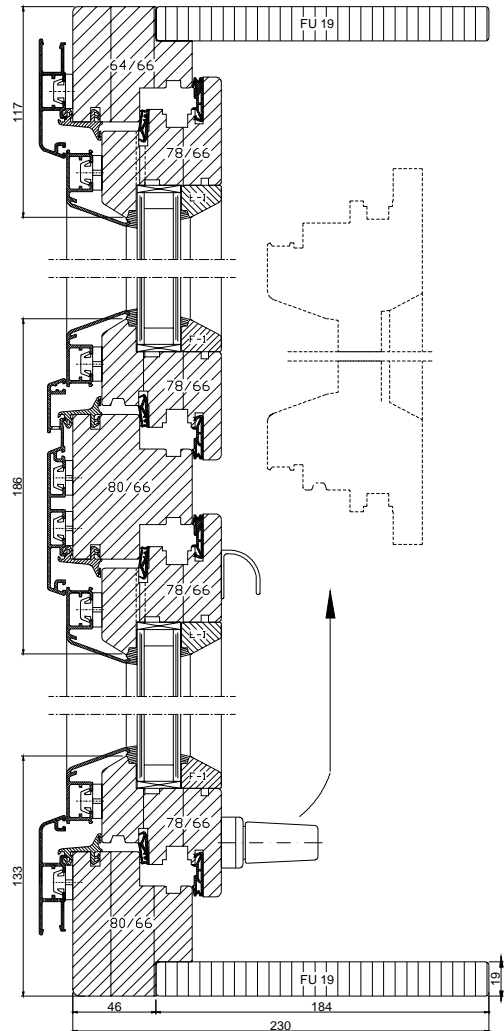

® (Holz-Metall) -
Ausführung VSF-HoMe 31061
Schnitt F - F

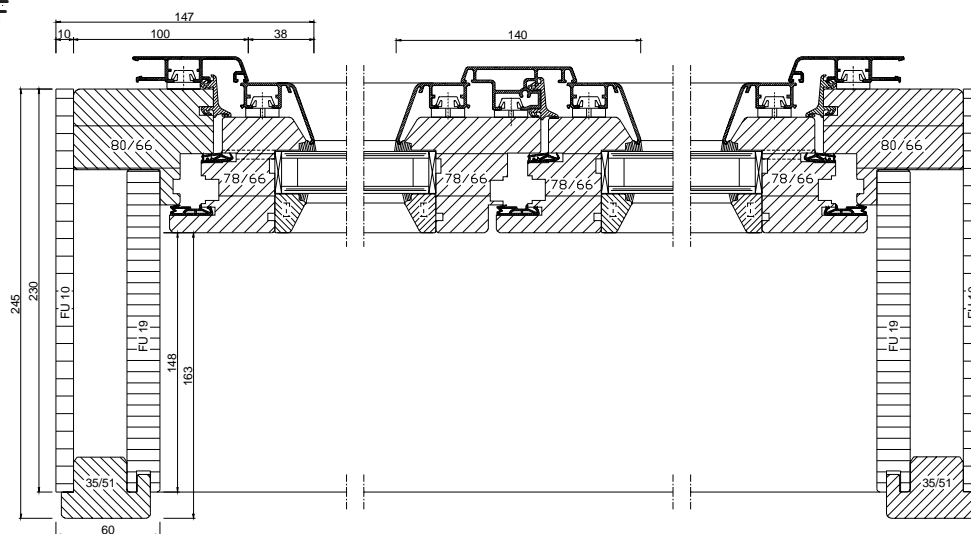

® (Holz-Metall) - Ausführung VSF-HoMe 21031

Schnitt E - E

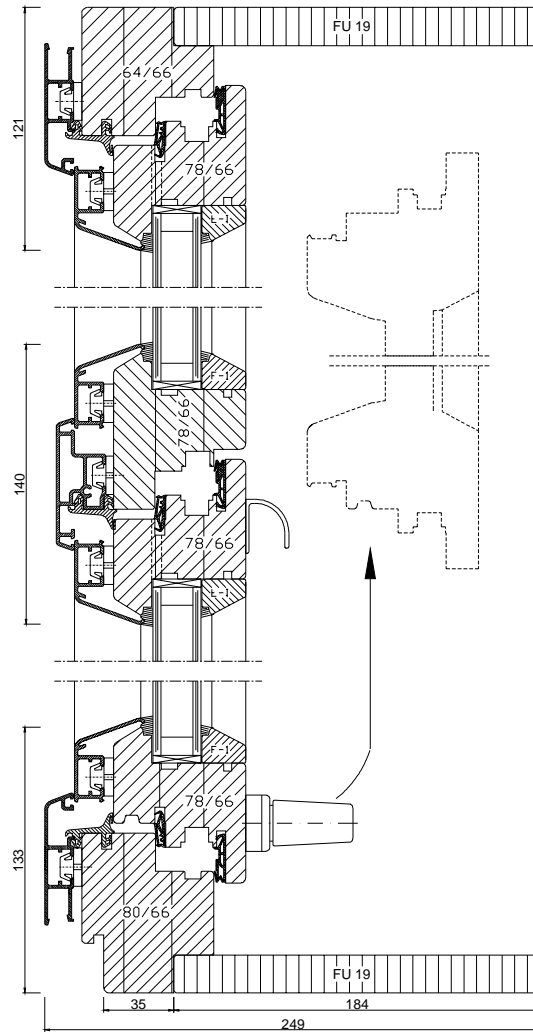

® (Holz-Metall) - Ausführung VSF-HoMe 31071

Schnitt G - G

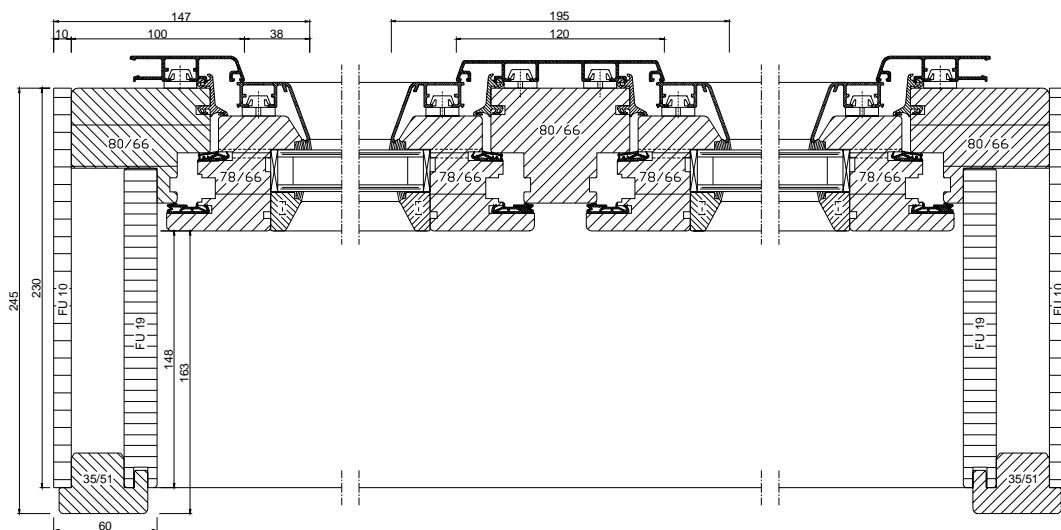

Info

1